

# Miya

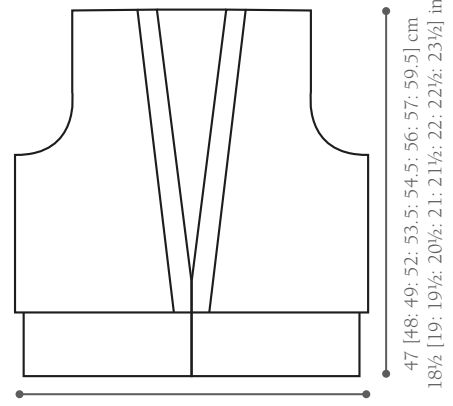

44 [48.5; 53.5; 57; 62.5; 66.5; 72; 76; 81] cm  
17¼ [19; 21; 22½; 24½; 26¼; 28¼; 30; 32] in

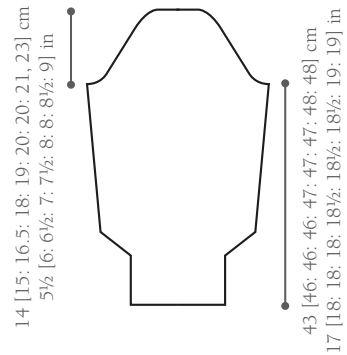

## SIZE

To fit bust

71-76	81-86	91-97	102-107	112-117	122-127	132-137	142-147	152-157	cm
28-30	32-34	36-38	40-42	44-46	48-50	52-54	56-58	60-62	in

Actual bust measurement of garment

88	97	107	114	125	133	144	152	162	cm
34.5	38	42	45	49	52.5	56.5	60	64	in

## YARN

Pure Cashmere

7	7	7	8	8	9	9	10	10	x 50gm
---	---	---	---	---	---	---	----	----	--------

(photographed in Dawn 92)

## NEEDLES

1 pair 4mm (no 8) (US 6) needles

## TENSION

23 sts and 32 rows to 10cm/4in measured over P2, K1 Rib using 4mm (US 6) needles

## EXTRAS

Stitch holders

Stitch markers

3 buttons

# •••• Hartley

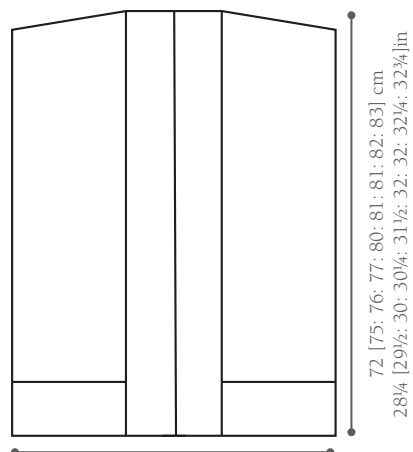

50 [55: 60: 65: 70: 75: 80: 85: 90] cm  
19 1/2 [21 1/2: 23 1/2: 25 1/2: 27 1/2: 29 1/2: 31 1/2: 33 1/2: 35 1/2] in

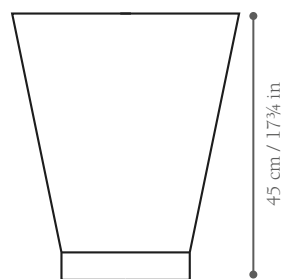

## SIZE

To fit bust

71-76	81-86	91-97	102-107	112-117	122-127	132-137	142-147	152-157	cm
28-30	32-34	36-38	40-42	44-46	48-50	52-54	56-58	60-62	in

Actual bust measurement of garment

100	110	120	130	140	150	160	170	180	cm
39	43	47	51	55	59	63	67	71	in

## YARN

Pure Cashmere

9	9	10	10	11	11	12	12	13	x 50gm
---	---	----	----	----	----	----	----	----	--------

(photographed in Port 93)

## NEEDLES

1 pair each sizes 3.5mm (no 9 / 10) (US 4) and 3.75mm (no 9) (US 5) needles

## TENSION

22 sts and 30 rows to 10cm/4in measured over st st using 3.75mm (US 5) needles

## EXTRAS

Stitch holders

Stitch markers

# •••• Joslyn



## SIZE

To fit an average-sized adult woman's head

Actual circumference 48cm/19in

## YARN

Pure Cashmere

1 x 50gm

(photographed in Potash 99)

## NEEDLES

1 pair size 3.5mm (no 9/10) (US 4) needles

## TENSION

23 sts and 34 rows to 10cm/4in measured over K1, P1 Rib using 3.5mm (US 4) when slightly stretched

## SPECIAL ABBREVIATIONS

**S2KP:** Slip 2 sts tog knitwise as if to K2tog, K1, pass 2 slipped sts over K1. 2 sts dec'd

# Calla

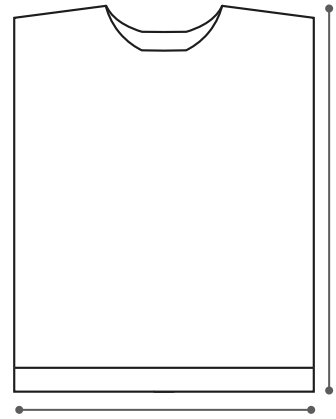

64 [66: 67: 68: 70: 72: 73: 75.5: 76.5] cm  
25¼ [26: 26½: 26¾: 27½: 28¾: 28¾: 29¾: 30¼] in

45 [50: 53: 60: 65: 68.5: 76: 82: 86] cm  
17¾ [19½: 21: 23¾: 25½: 27: 29¾: 32¼: 34] in

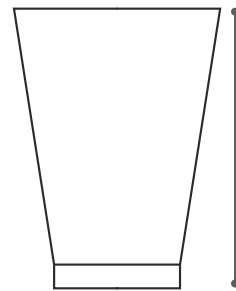

47 cm / 18½ in

## SIZE

To fit bust

71-76	81-86	91-97	102-107	112-117	122-127	132-137	142-147	152-157	cm
28-30	32-34	36-38	40-42	44-46	48-50	52-54	56-58	60-62	in

Actual bust measurement of garment

90	100	106	120	130	137	152	164	172	cm
35.5	39	42	47.5	51	54	59.5	64.5	68	in

## YARN

Pure Cashmere

10	11	11	12	12	13	13	14	15	x 50gm
----	----	----	----	----	----	----	----	----	--------

(photographed in Light 15)

## NEEDLES

1 pair each sizes 3.5mm (no 9/10) (US 4) and 3.75mm (no 9) (US 5) needles

1 x 3.5mm (no 9/10) (US 4) circular needle

## TENSION

28 sts and 30 rows to 10 cm/4 in measured over cable pattern using 3.75mm (US 5) needles

## EXTRAS

Cable needle

Stitch markers

**Note:** st st rows at the lower hem and sleeve cuff edges are not included in the finished length measurements or shown on the schematics.

# Fleur



Front

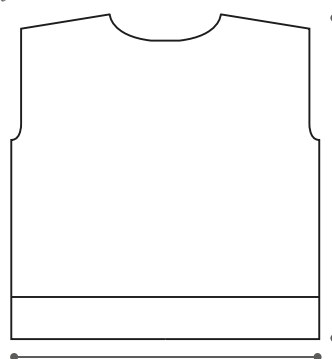

45 (50: 55: 60: 65: 70: 75: 80: 85] cm  
17½ (19½: 21½: 23½: 25½: 27½: 29½: 31½: 33½] in

55 [56: 57: 59: 61: 62.5: 64: 65.5: 67] cm  
21¾ [22: 22½: 23¼: 24: 24½: 25¼: 25¾: 26½] in

Back

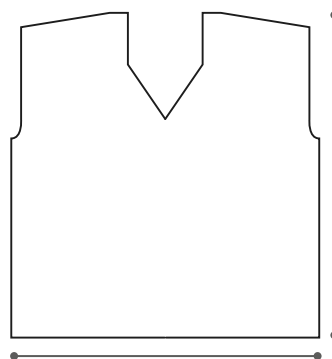

45 (50: 55: 60: 65: 70: 75: 80: 85] cm  
17½ (19½: 21½: 23½: 25½: 27½: 29½: 31½: 33½] in

55 [56: 57: 59: 61: 62.5: 64: 65.5: 67] cm  
21¾ [22: 22½: 23¼: 24: 24½: 25¼: 25¾: 26½] in

## SIZE

To fit bust

71-76	81-86	91-97	102-107	112-117	122-127	132-137	142-147	152-157	cm
28-30	32-34	36-38	40-42	44-46	48-50	52-54	56-58	60-62	in

Actual bust measurement of garment

90	100	110	120	130	140	150	160	170	cm
35	39	43	47	51	55	59	63	67	in

## YARN

Pure Cashmere

5	5	6	6	7	7	8	8	9	x 50gm
---	---	---	---	---	---	---	---	---	--------

(photographed in Flannel 100)

## NEEDLES

1 pair each 3.5mm (no 9/10) (US 4) and 3.75mm (no 9) (US 5) needles

1 each 3.5mm (no 9/10) (US 4) and 3.75mm (no 9) (US 5) circular needle

1 size 3.75mm (no 9) (US 5) double-pointed needle for I-cord cast-off

## TENSION

22 sts and 30 rows to 10cm/4 in measured over st st using 3.75mm (US 5) needles

## EXTRAS

Stitch holders

# Taylor



## SIZE

To fit bust

71-97	102-127	132-157	cm
-------	---------	---------	----

28-38	40-50	52-62	in
-------	-------	-------	----

Actual circumference of garment at hem

117	143.5	172	cm
-----	-------	-----	----

46	56½	67¾	in
----	-----	-----	----

## YARN

Pure Cashmere

3	4	5	x 50gm
---	---	---	--------

(photographed in Light 95)

## NEEDLES

1 each 3.5mm (no 9/10) (US 4) circular needles 40cm and 80cm long

## TENSION

23 sts and 34 rows to 10cm/4in measured over K1, P1 rib using 3.5mm (US 4) needles when slightly stretched

## EXTRA

Stitch marker



# ... Caggie



## SIZE

Finished wrap meas 41cm (16¼in) wide and 160cm (63in) long.

## YARN

Pure Cashmere

A Light 95

2 x 50gm

B Chalk 94

5 x 50gm

## NEEDLES

1 pair size 3.75mm (no 9) (US 5) needles

## TENSION

22 sts and 30 rows to 10cm/4in measured over st st using 3.75mm (US 5) when slightly stretched

**Note:** Wind two equal balls of colour A for borders. When changing colours, twist yarns on WS to prevent holes in work.

# Shay



## SIZE

To fit an average-sized adult woman's head. Completed hat circumference 50cm/20in.

## YARN

Rowan Pure Cashmere

1 x 50gm

(photographed in Light 095)

## NEEDLES

1 pair 3.75mm (no 9) (US 5) needles

Set of 4 double-pointed 3.75mm (no 9) (US 5) needles

## TENSION

22 sts and 30 rows to 10cm/4in measured over st st, using 3.75mm (US 5) needles



# Dinah

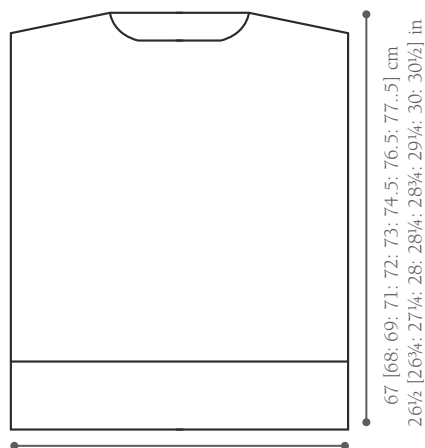

50 [55: 60: 65: 70: 75: 80: 85: 90] cm  
19½ [21½: 23½: 25½: 27½: 29½: 31½: 33½: 35½] in

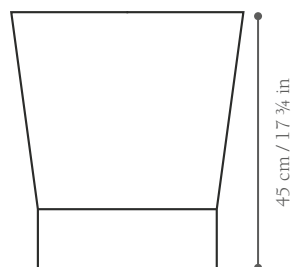

## SIZE

To fit bust

71-76	81-86	91-97	102-107	112-117	122-127	132-137	142-147	152-157	cm
28-30	32-34	36-38	40-42	44-46	48-50	52-54	56-58	60-62	in

Actual bust measurement of garment

100	110	120	130	140	150	160	170	180	cm
39	43	47	51	55	59	63	67	71	in

## YARN

Pure Cashmere

9	10	10	11	12	13	13	14	15	x 50gm
---	----	----	----	----	----	----	----	----	--------

(photographed in Potash 99)

## NEEDLES

1 pair 3.75mm (no 9) (US 5) needles

1 x 3.75mm (no 9) (US 5) circular needle

## TENSION

22 sts and 30 rows to 10cm/4in measured over st st using 3.75mm (US 5) needles

## EXTRAS

Stitch holders

Stitch markers

# Ina

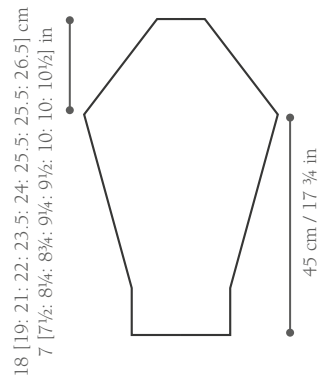
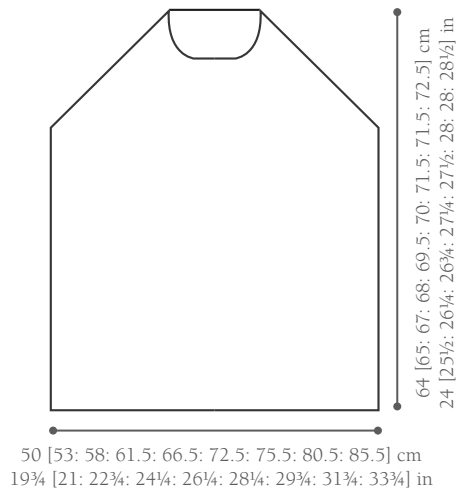

## SIZE

To fit bust

71-76	81-86	91-97	102-107	112-117	122-127	132-137	142-147	152-157	cm
28-30	32-34	36-38	40-42	44-46	48-50	52-54	56-58	60-62	cm

Actual bust measurement of garment

100	106	116	123	133	145	151	161	171	cm
39.5	42	45.5	48.5	52.5	56.5	59.5	63.5	67.5	in

## YARN

Pure Cashmere

12	12	13	13	14	14	15	15	16	x 50gm
----	----	----	----	----	----	----	----	----	--------

(photographed in Light 95)

## NEEDLES

- 1 pair 3.5mm (no 9 / 10) (US 4) needles
- 1 size 3.5mm (no 9 / 10) (US 4) circular needle

## TENSION

- 32 sts and 32 rows to 10cm/4in measured over K2, P2 Rib using 3.5mm (US 4) needles, when very slightly stretched
- 28 sts and 34 rows to 10cm/4in measured over stocking st using 3.5mm (US 4) needles

## EXTRAS

- Stitch holders
- Stitch markers