



001 vest top

by quail studio

SIZE	S	M	L	XL	XXL	
To fit bust	81-86	91-97	102-107	112-117	122-127	cm
	32-34	36-38	40-42	44-46	48-50	in
Actual bust measurement	96	107	117	127	137	cm
	37 ¾	42 ¼	46	50	54	in

YARN

Summerlite 4ply (photographed in Pure White 417)

	4	5	5	6	6	x 50gm
--	---	---	---	---	---	--------

NEEDLES

1 pair 3mm (no 11) (US 2/3) needles

TENSION

28 sts and 36 rows to 10 cm measured over st st using 3mm (US 2/3) needles.

EXTRAS

Stitch Holder

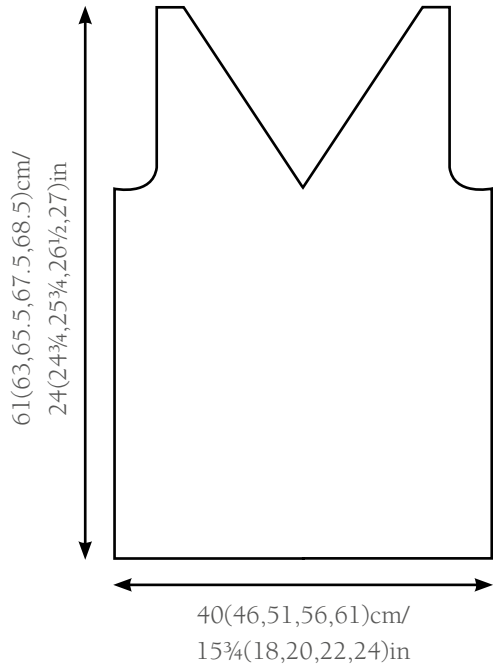



002

d i a m o n d t o p

by quail studio

SIZE	S	M	L	XL	XXL	
To fit bust	81-86	91-97	102-107	112-117	122-127	cm
	32-34	36-38	40-42	44-46	48-50	in
Actual bust measurement	92	100	110	119	128	cm
	36½	39¼	43	47	50½	in

YARN

Handknit Cotton (photographed in Linen 205)

7	7	8	8	9	x 50gm
---	---	---	---	---	--------

NEEDLES

1 pair 4½mm (no 7) (US 7) needles

TENSION

19 sts and 34 rows to 10 cm measured over garter stitch using 4½mm (US 7) needles.

EXTRAS

Stitch Holders

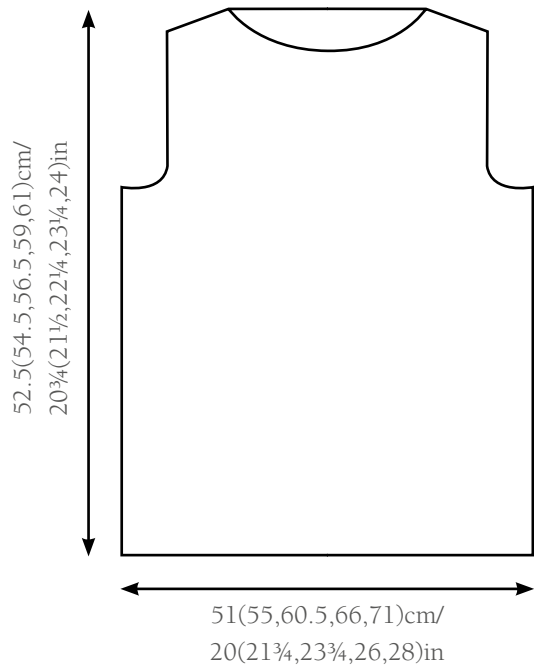



003 oversized v-neck

by quail studio

SIZE	S	M	L	XL	XXL	
To fit bust	81-86	91-97	102-107	112-117	122-127	cm
	32-34	36-38	40-42	44-46	48-50	in
Actual bust measurement	112	122	132	142	152	cm
	44	48	52	56	59¾	in

YARN

Summerlite 4ply (photographed in Washed Linen 418)

6	6	7	7	8	x 50gm
---	---	---	---	---	--------

NEEDLES

- 1 pair 3mm (no 11) (US 2/3) needles
- 1 pair 4mm (no 8) (US 6) needles
- 1 pair 6½mm (no 3) (US 10.5/11) needles

TENSION

20 sts and 24 rows to 10 cm measured over st st using 4mm (US 6) and 6½mm (US 10.5/11) needles.

EXTRAS

- Stitch Markers
- Stitch Holder

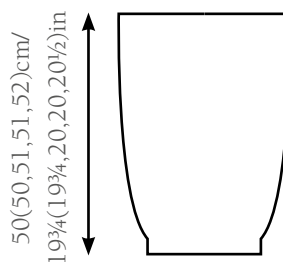
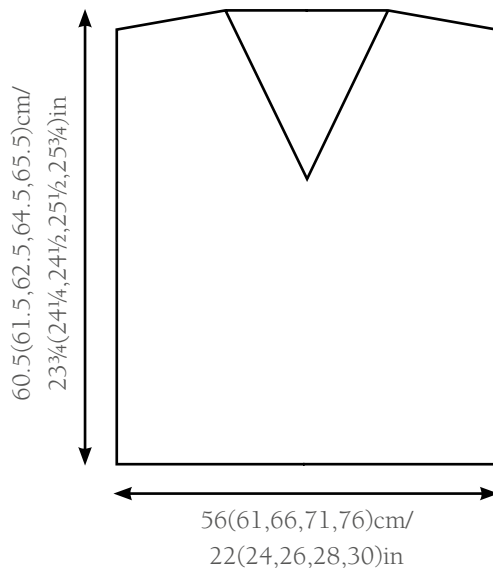



004 oversized cardigan

by quail studio

SIZE	S	M	L	XL	XXL	
To fit bust	81-86	91-97	102-107	112-117	122-127	cm
	32-34	36-38	40-42	44-46	48-50	in
Actual bust measurement	110	121	130	141	152	cm
	43½	47¾	51	55½	59¾	in

YARN

Cotton Cashmere (photographed in Paper 210)

	16	18	18	20	20	x 50gm
--	----	----	----	----	----	--------

NEEDLES

1 pair 6mm (no 4) (US 10) needles

6mm (no 4) (US 10) circular needles at least 150 cm long

TENSION

14½ sts and 25 rows to 10 cm measured over pattern using 6mm (US 10) needles and yarn held double throughout.

EXTRAS

Stitch holders
Stitch markers

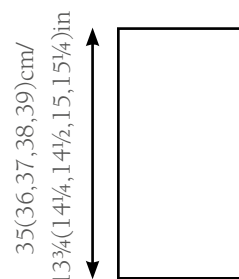
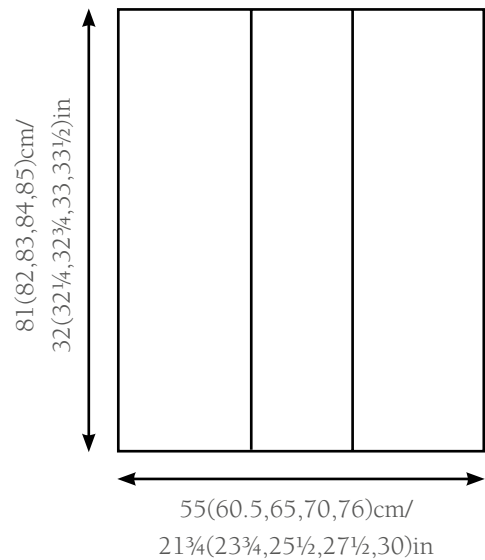



005 lace sweater

by chloe thurlow

SIZE	S	M	L	XL	XXL	
To fit bust	81-86	91-97	102-107	112-117	122-127	cm
	32-34	36-38	40-42	44-46	48-50	in
Actual bust measurement	94.5	105.5	115.5	125.5	135.5	cm
	37¼	41½	45½	49½	53¼	in

YARN

Summerlite 4ply (photographed in Pure White 417)

	6	6	7	7	8	x 50gm
--	---	---	---	---	---	--------

NEEDLES

1 pair 2½mm (no 13/12) (US 1/2) needles

1 pair 3mm (no 11) (US 2/3) needles

TENSION

28 sts and 36 rows to 10cm measured over st st using 3mm (US 2/3) needles

EXTRAS

Stitch Holders

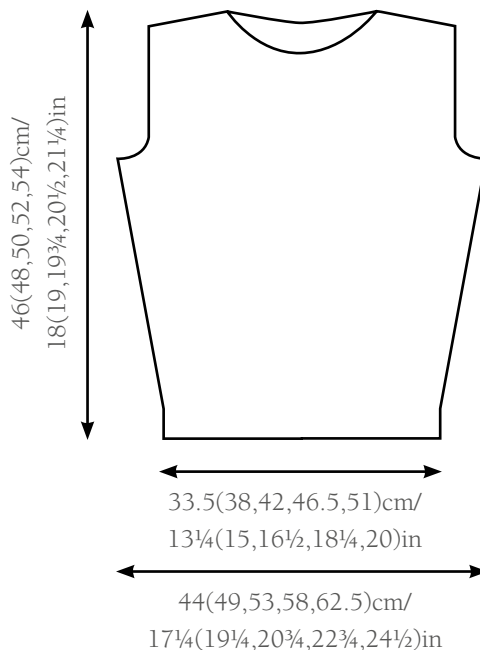
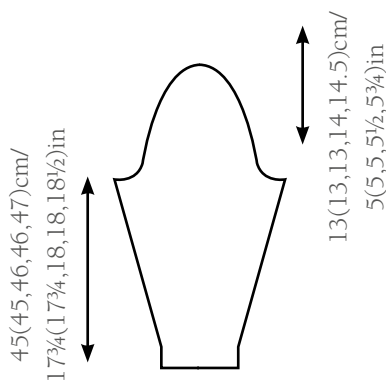



006 striped tank top

by chloe thurlow

SIZE	S	M	L	XL	XXL	
To fit bust	81-86	91-97	102-107	112-117	122-127	cm
	32-34	36-38	40-42	44-46	48-50	in
Actual bust measurement	92	102	112	122	132	cm
	36 ¼	40 ¼	44	48	52	in

YARN

Handknit Cotton

A – Linen 205

	6	6	7	7	8	x 50gm
--	---	---	---	---	---	--------

B – Bleached 263

	1	1	1	1	1	x 50gm
--	---	---	---	---	---	--------

NEEDLES

1 pair 3¼mm (no 10) (US 3) needles

3¼mm (no 10) (US 3) circular needle

1 pair 4mm (no 8) (US 6) needles

TENSION

20 sts and 30 rows to 10 cm measured over st st using 4mm (US 6) needles.

EXTRAS

Stitch Holder
Stitch Markers

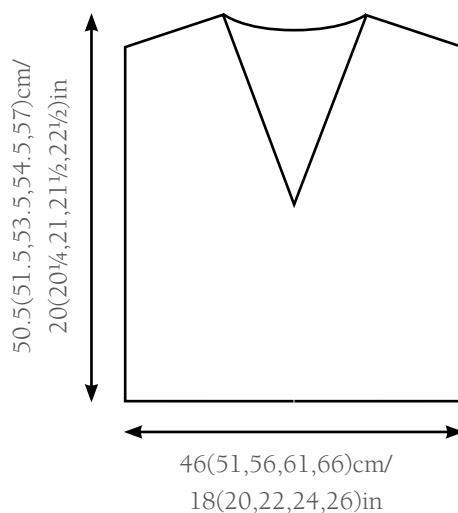



007

longline cardigan

by georgia farrell

SIZE	S	M	L	XL	XXL	
To fit bust	81-86	91-97	102-107	112-117	122-127	cm
	32-34	36-38	40-42	44-46	48-50	in
Actual bust measurement	105	119	126	133	140	cm
	41¼	46¾	49½	52¼	55	in

YARN

Creative Linen (photographed in Silver 650)

5	5	6	6	6	x 50gm
---	---	---	---	---	--------

NEEDLES

1 pair 4½mm (no 7) (US 7) needles

4mm (no 8) (US 6) circular needle, 150 cm long

TENSION

20 sts and 28 rows to 10 cm measured over pattern using 4½mm (US 7) needles.

EXTRAS

Stitch Marker
Stitch Holder

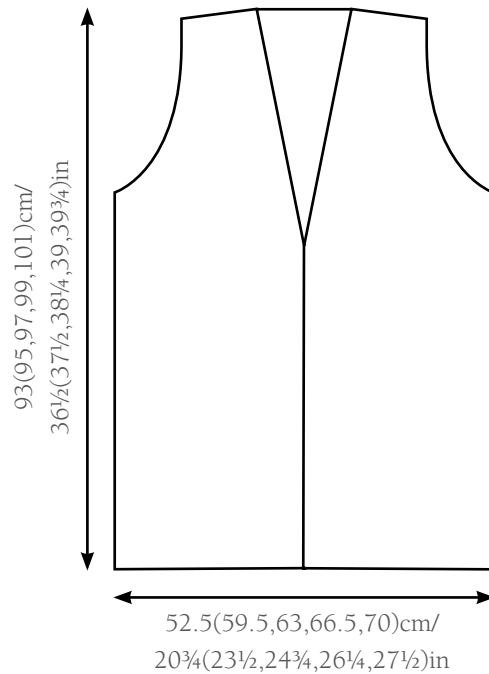



008

loose fit cardigan

by georgia farrell

SIZE	S	M	L	XL	XXL	
To fit bust	81-86	91-97	102-107	112-117	122-127	cm
	32-34	36-38	40-42	44-46	48-50	in
Actual bust	96	105	118	127	137	cm
measurement	37¾	41½	46½	50	54	in

YARN

Cotton Cashmere (photographed in Morning Sky 221)

	11	11	13	14	14	x 50gm
--	----	----	----	----	----	--------

NEEDLES

	1 pair 4mm (no 8) (US 6) needles					
--	----------------------------------	--	--	--	--	--

TENSION

19 sts and 30 rows to 10 cm measured over patt using 4mm (US 6) needles.

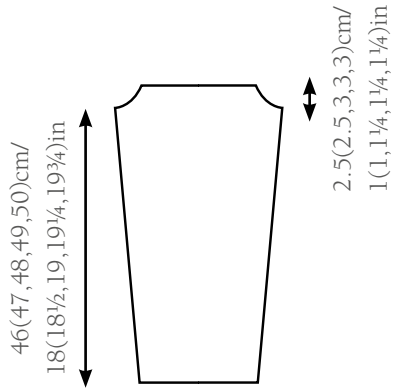
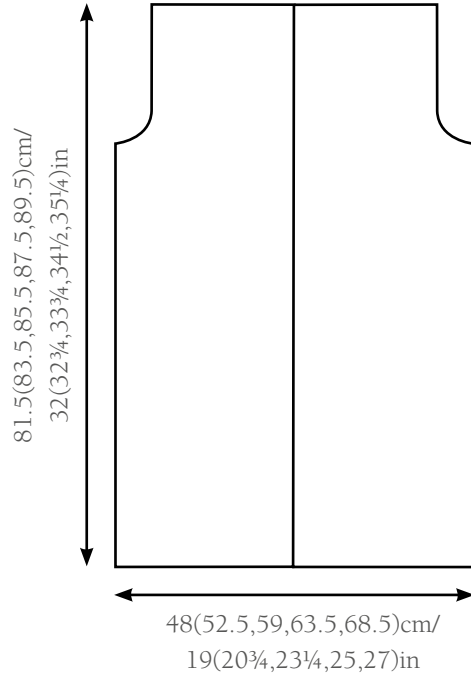



009

cable bobble sweater

by martin storey

SIZE	S	M	L	XL	XXL	
To fit bust	81-86	91-97	102-107	112-117	122-127	cm
	32-34	36-38	40-42	44-46	48-50	in
Actual bust measurement	102.5	113.5	123.5	133.5	143.5	cm
	40¼	44¾	48½	52½	56	in

YARN

Cotton Cashmere (photographed in Paper 210)

14	15	16	17	18	x 50gm
----	----	----	----	----	--------

NEEDLES

1 pair 3¼mm (no 10) (US 3) needles

1 pair 3¾mm (no 9) (US 5) needles

TENSION

31 sts and 34 rows to 10 cm measured over cable pattern using 3¾mm (US 5) needles

EXTRAS

Cable needle
Stitch markers
Stitch holders

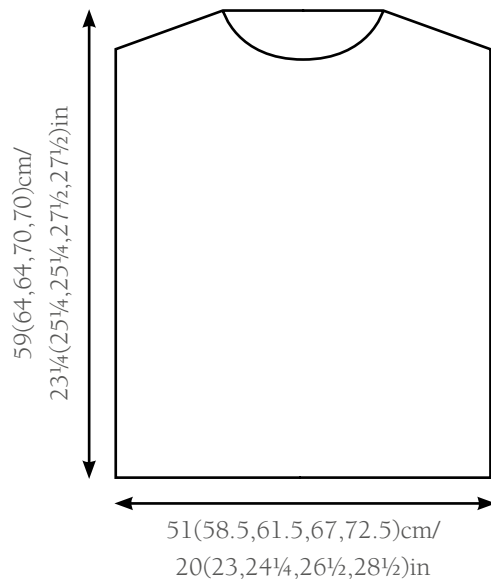
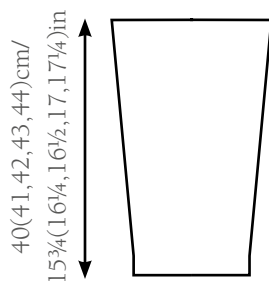



010 cable sweater

by lisa richardson

SIZE	S	M	L	XL	XXL	
To fit bust	81-86	91-97	102-107	112-117	122-127	cm
	32-34	36-38	40-42	44-46	48-50	in
Actual bust measurement	116	126	133	140	148	cm
	45¾	49½	52½	55¼	58¼	in

YARN

Creative Linen (photographed in Cloud 620)

6	7	7	8	9	x 100gm
---	---	---	---	---	---------

NEEDLES

1 pair 4mm (no 8) (US 6) needles
1 pair 4½mm (no 7) (US 7) needles

TENSION

22½ sts and 27 rows to 10 cm measured over trellis with moss stitch using 4½mm (US 7) needles.

SPECIAL ABBREVIATIONS

- T3F** Slip next 2 sts onto cn and hold at front, P1, then K2 from cn
- T3B** Slip next st onto cn and hold at back, K2, then P1 from cn
- C3F** Slip next 2 sts onto cn and hold at front, K1, then K2 from cn
- C4F** Slip next 2 sts onto cn and hold at front, K2, then K2 from cn
- C5B** Slip next 4 sts onto cn and hold at back, K1, slip last 3 sts from cn onto lh needle, move cn to front, K3, then K1 from cn

EXTRAS

Stitch Holders

Cable needle

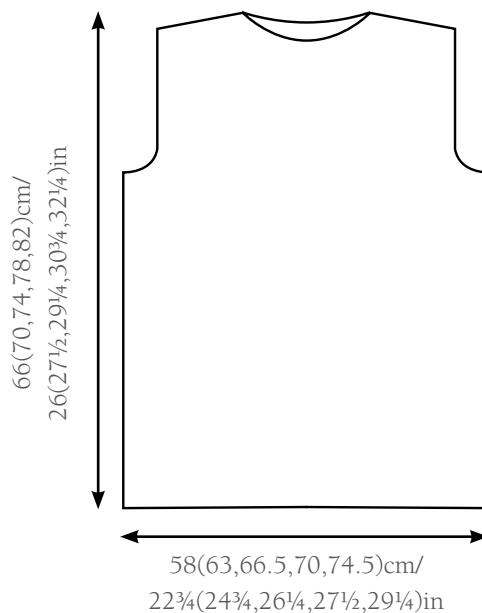
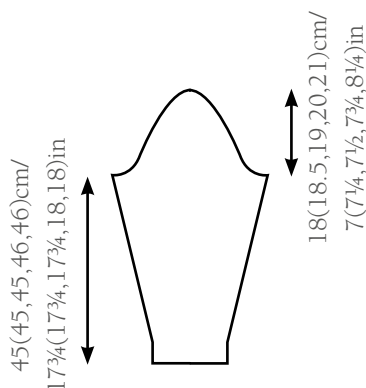



011 t - s h i r t

by annika andrea wolke

SIZE	S	M	L	XL	XXL	
To fit bust	81-86	91-97	102-107	112-117	122-127	cm
	32-34	36-38	40-42	44-46	48-50	in

Actual bust measurement	133	143	154	164	175	cm
	52¼	56½	60½	64½	68¾	in

YARN

Cotton Cashmere (photographed in Morning Sky 221)

	6	7	7	8	8	x 50gm
--	---	---	---	---	---	--------

NEEDLES

1 pair 3¾mm (no 9) (US 5) needles

1 pair 4mm (no 8) (US 6) needles

TENSION

19–20 sts and 24 rows to 10 cm measured over pattern using 4mm (US 6) needles

EXTRAS

Stitch Markers

Stitch Holders

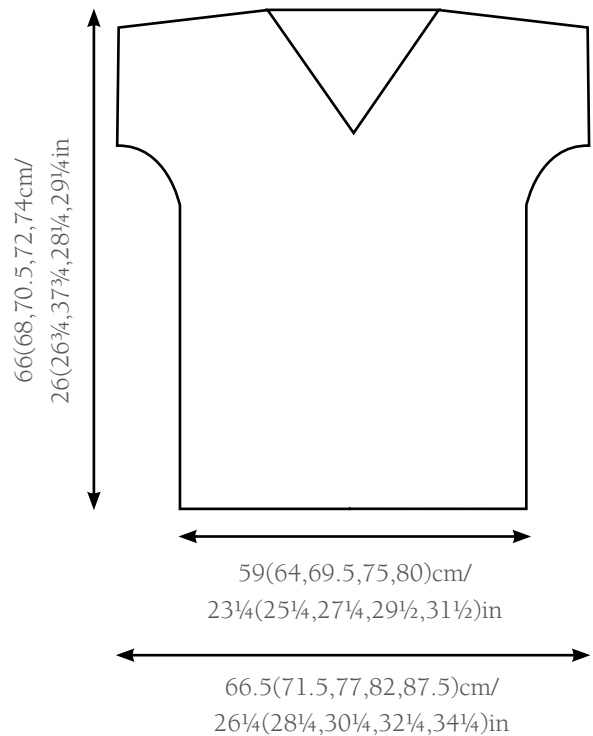

012 shawl

by martin storey



SIZE

44.5 cm wide x 226 cm long

YARN

Summerlite DK & Kidsilk Haze

A – White 465 (sl)	5	x 50gm
B – White 612 (ksh)	2	x 25gm

NEEDLES

1 pair 3¼mm (no 10) (US 3) needles

TENSION

32 sts and 30 rows to 10 cm measured over rib pattern using 3¼mm (US 3) needles.